



COMPANY PROFILE

(Mechanical ,Electrical Plumbing Contracting Company)

 **0304.8902805**

 **0512763508**

 **QUERY@PLUMBCOENGINEERING.COM**

 **[HTTPS://PLUMBCOENGINEERING.COM/](https://plumbcengineering.com/)**



TABLE OF CONTENT

1 ● ABOUT US

2 ● WHAT WE PROMISE

3 ● OUR SERVICES

4 ● STAFF

5 ● CONTACTS DETAILS

● DIRECTOR MESSAGE

● HUMAN RESOURCES POLICY

● OUR CLIENTS

● TOOLS / EQUIPMENTS

● VISSION

● PARTNERS

● PROJECTS

● REGISTRATION



ABOUT US

PLUMBCO ENGINEERING PVT LTD IS LEAD TO PROJECTS RELATED COMMERCIAL PLUMBING PROJECTS , FIRE FIGHTING SYSTEM INSTALLATION IN COMMERCIAL LEVELS , ELECTRICAL PROJECTS . WE HAVE DONE MANY COMMERCIAL PLUMBING PROJECTS . PLUMBCO ENGINEERING PVT LTD HAVE A LOT OF EXPERIENCE IN HEIGH RISED BUILDING , INDUSTRIAL PROJECTS , SHOPPING MALLS , OTHER COMMERCIAL MEP WORK . PLUMBCO ENGINEERING PVT LTD REIGSTERD AS PVT LTD FIRM SINCE 2022 , BEFORE REGISTRATION WORKED AS A RAZZAQ ENGINEERING SERVICES .





PLUMBCO ENGINEERING (PVT) LTD
YOUR PLUMBING PARTNER

DIRECTOR MESSAGE

A MESSAGE BY DIRECTOR (PLUMBCO ENGINEERING PVT LTD) MOHAMMAD RAZZAQ FOR CLIENTS. WE COMMIT TO ENSURE THE ULTIMATE LEVEL OF CUSTOMER SATISFACTION BY PROVIDING UNRIVALED LEADERSHIP IN THE SERVICE INDUSTRY. OFFERING PEACE OF MIND THROUGH QUALITY CUSTOMER SERVICE. DEDICATED TO EMPOWERING A MOTIVATED TEAM ENVIRONMENT AND RECOGNIZING THE VALUE OF EACH EMPLOYEE'S CONTRIBUTIONS. AGGRESSIVELY INCREASING OUR MARKET SHARE BY EARNING ONE CUSTOMER'S LOYALTY AT A TIME. AN INTENSE DESIRE TO ACHIEVE A HIGHER STANDARD OF EXCELLENCE BY PROVIDING HIGH QUALITY WORKMANSHIP AND VALUE WITH CONTINUOUS IMPROVEMENTS AND GROWTH. COMMUNICATION THAT IS CLEAR AND OPEN AT ALL LEVELS OF THE ORGANIZATION. WE BELIEVE THAT A STRONG ENDORSEMENT FROM OUR CLIENT IS OUR BEST ADVERTISEMENT. WE WILL TREAT YOUR HOME AND PROPERTY WITH RESPECT, OFFER YOU A GREAT PRICE AND GIVE YOU MY PERSONAL GUARANTEE THAT THE WORK WILL BE DONE TO YOUR SATISFACTION

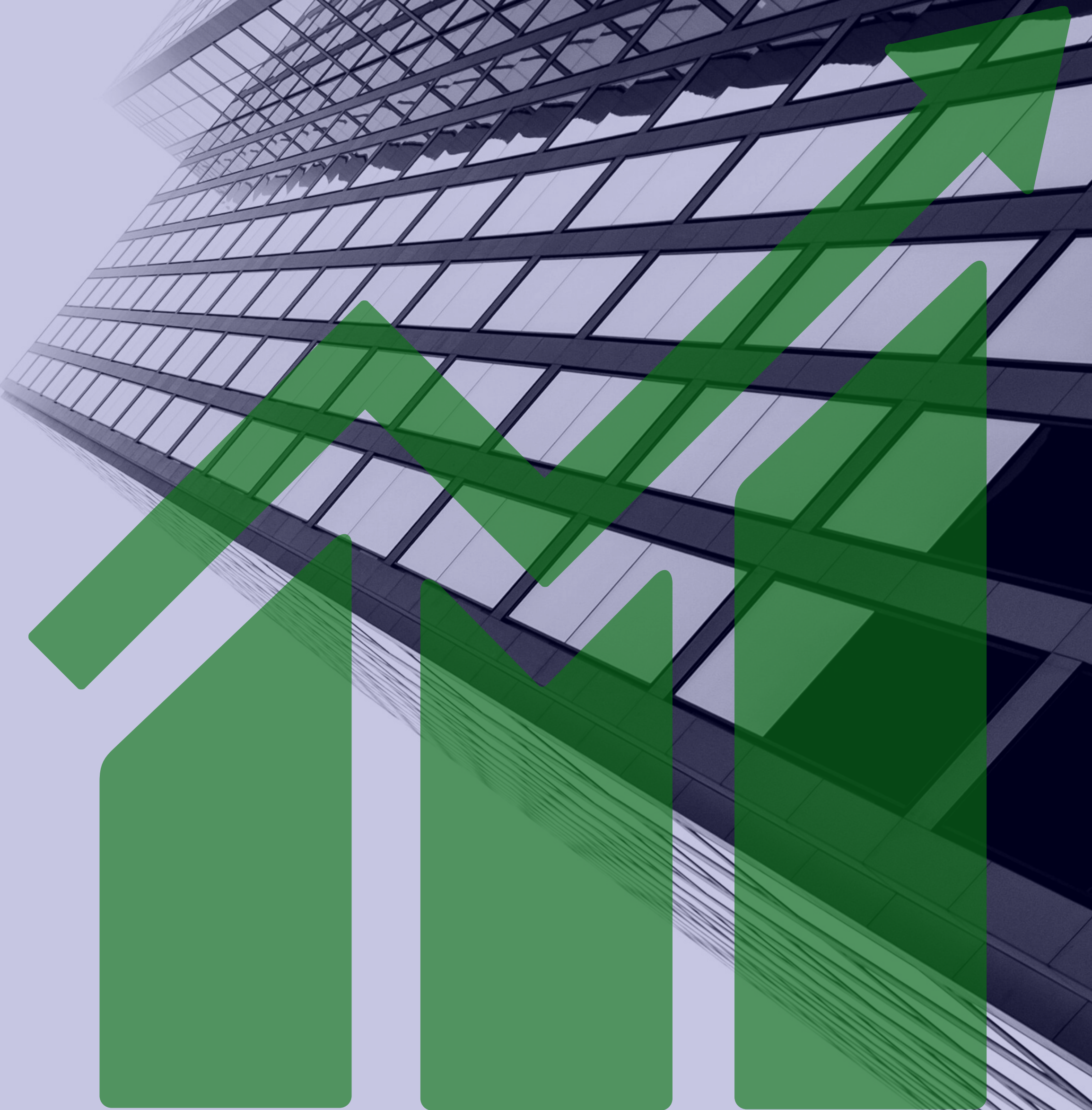

VISSION

OUR VISION IS TO PROVIDE CLIENTS WITH PROFESSIONAL, FAST AND RELIABLE SOLUTIONS THAT BEST SUIT AND SERVICE THEIR NEEDS. WE PROVIDE SERVICES WITH QUALITY AND EXCELLENT THAT EXCEED CUSTOMERS .EXPECTATION IN THE BUILDING INDUSTRY AND TO CREATE LONG TERM RELATIONSHIPS WITH OUR CLIENTS.





PLUMBCO ENGINEERING (PVT) LTD
YOUR PLUMBING PARTNER

WHAT WE PROMISE

SOME CORE VALUES OF PLUMBCO ENGINEERING PVT LTD WRITTEN BELOW

- 1. 24/7 AVAILABILITY**
- 2. WE ARE FLEXIBLE**
- 4. DYNAMIC & INNOVATIVE**
- 5. RELATIONSHIP**
- 6. LATEST EQUIPMENT / TOOLS**
- 7. EXPERT TEAM**
- 8. RESPECT**
- 9. GOOD HOUSEKEEPING**
- 10. STREAMLINED PROCESS**



HUMAN RESOURCES POLICY

OUR STAFF ARE WELL TRAINED AND WE STRIVE TO KEEP THEM ON A COMPETENT LEVEL IN THE PLUMBING INDUSTRY TO MAINTAIN AN OUTSTANDING SERVICE TO OUR CLIENTS IN TERMS OF THE LATEST TECHNOLOGY. OUR PRIMARY RESOURCE IS OUR EMPLOYEES AND THEREFORE WE FOCUS ON TRAINING, DEVELOPING AND MAINTAINING COMPETENT PEOPLE WITHIN OUR ORGANIZATION. OUR SERVICE IS OUR PRID



PARTNERS



RAZZAQ ENGINEERING SERVICES
IS LEADS MECHANICAL PLUMBING AND RCC DIAMOND
CORE CUTTING AND CONCRETE SAWING VIBRATION
FREE



DRILLPRO ENGINEERING PVT LTD
LEADS RCC CONCRETE SOLUTION
VIBRATION FREE SAWING CUTTING
CORING, INDUSTRIAL LEVEL



SUBHAN ENGINEERING & CONTRACTOR
IS LEADS ELECTRICAL & EARTHING FIELD IN
HIGH RISED BUILDINGS AND INDUSTRIAL
LEVEL.



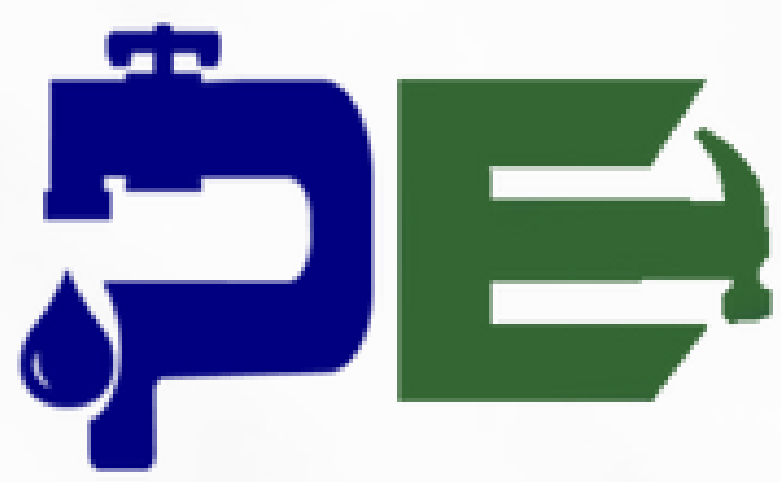

PLUMCO ENGINEERING (PVT) LTD
YOUR PLUMBING PARTNER

OUR SERVICES



COMMERCIAL PLUMBING

PROFESIONAL PLUMBING CONTRACTOR SHOPPING MAALLS , APPARTMENTS , WATER SUPPLY PIPING , SEWER PIPING WITH ALL RESPECTS



INDUSTRIAL PLUMBING

INDUSTRIAL PIPING HEIGN PRESSURE CONTROL PIPING WITH ALL RESPECTS

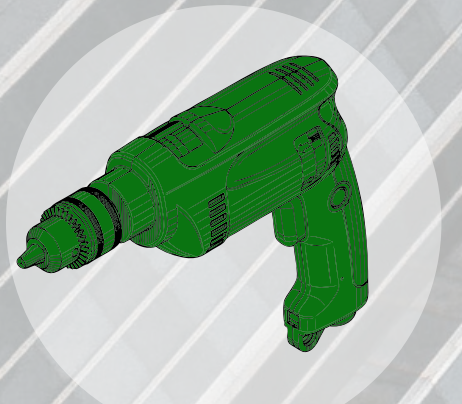

CORE CUTTING

RCC DIAMOND CORE CUTTING LARGE DIA CORING , INDUSTRIAL CORING VIBRATION FREE SERVICES



ELECTRICAL & EARTHING SYSTEM

ELECTRICAL SYSTEM INSTALLATION SERVICESIN HEIGH RISED BUILDINGS AND INDUSTRIAL LEVEL ELECTRICAL & EARTHING SYSYSTEM INSTALLATION



HEIGH RISED BUILDING MEP SERVICES

MEP SERVICES IN HEIGH RISED BUILDING PLUMBING ELECTRICAL AND MECHANICAL ACCORDING TO DRAWINGS PRESURE CONTROL SYSTEM INSTALLATION , SWMING POOL PIPING , WATER HEATING BOILER INSTALLATION ,PUMPS INSTALLATION WITH ALL RESPECTS



FIRE FIGHTING SYSTEM INSTALLATION

FIRE FIGHTING SYSTEM INSTALLATION , PIPING ISTALLATION ,SPRINKLE SYSTEM , FIRE HYDRANT , FIRE CABNET ETC



CONCRETE CUTTING SAWING ANTI VIBRATION

VIBRATION FREE CONCRETE CUTTING , WALL SAWING , WIRE SAWING VIBRATION FREE SERVICES

OUR CLIENTS



PARK VIEW CITY



J7 GROUP



UNIVERSITY OF LAHORE



CHERAT CEMENT



HAYAT KIMYA



GC UNIVERSITY FAISALABAD



OUR CLIENTS



TOTAL PARCO



K ELECTRIC



INDIGO DEVELOPERS



DESCON ENGINEERING



FEROBEL GROUP



MONNO GROUP OF INDUSTRIES



OUR TEAM



MOHAMMAD RAZZAQ

COMPANY DIRECTOR

Mohammad Razzaq is a Mechanical Engineer and Director of Plumbco Engineering pvt ltd . he has 25 years + experience in mechanical , plumbing fields.



SAIF UR REHMAN

C.E.O COMPANY

SAIF UR REHMAN IS BS (MECH) ENGINEER AND C.E.O OF PLUMBCO ENGINEERING PVT LTD . HE HAS 10 YEAR EXPERIENCE PARTICULAR FIELD PLUMBING , FIRE FIGHTING AND BUISNESS RRELATIONSHIP



MOHAMMAD AZIM

PROJECT DIRECTOR

MOHAMMAD AZAM IS ELECTRICAL ENGINEER PROJECT DIRECTOR IN PLUMBCO ENGINEERING PVT LTD . HE HAS 25 YEARS EXPERIENCE IN ELECTRICAL FIELD



MOHAMMAD SHAHZAD

FINANCE MANGER

MOHAMMAD SHAHZAD M PHIL MATH . HE IS FINANCE MANGER IN PLUMBCO ENGINEERING PVT LTD

TOOLS / EQUIPMENTS LIST

No's	Items	Unit	Qty
01	Plumbing Tools Kit Complete	No's	32.00
02	Electrical Toolkits	No's	28.00
03	HDPE AUTO HEATER MACHINE	No's	03.00
04	GI THREADING MACHINE LARGE DIA AUTO	No's	04.00
05	Fire Fighting Tool Kit	No's	14.00
06	Rcc Core Cutting Machine	No's	120.00
07	Rcc Concrete Sawing Machine wall sawing vibration free	No's	14.00
08	Rcc concrete Wire Sawing Machine anti Vibration	No's	02.00

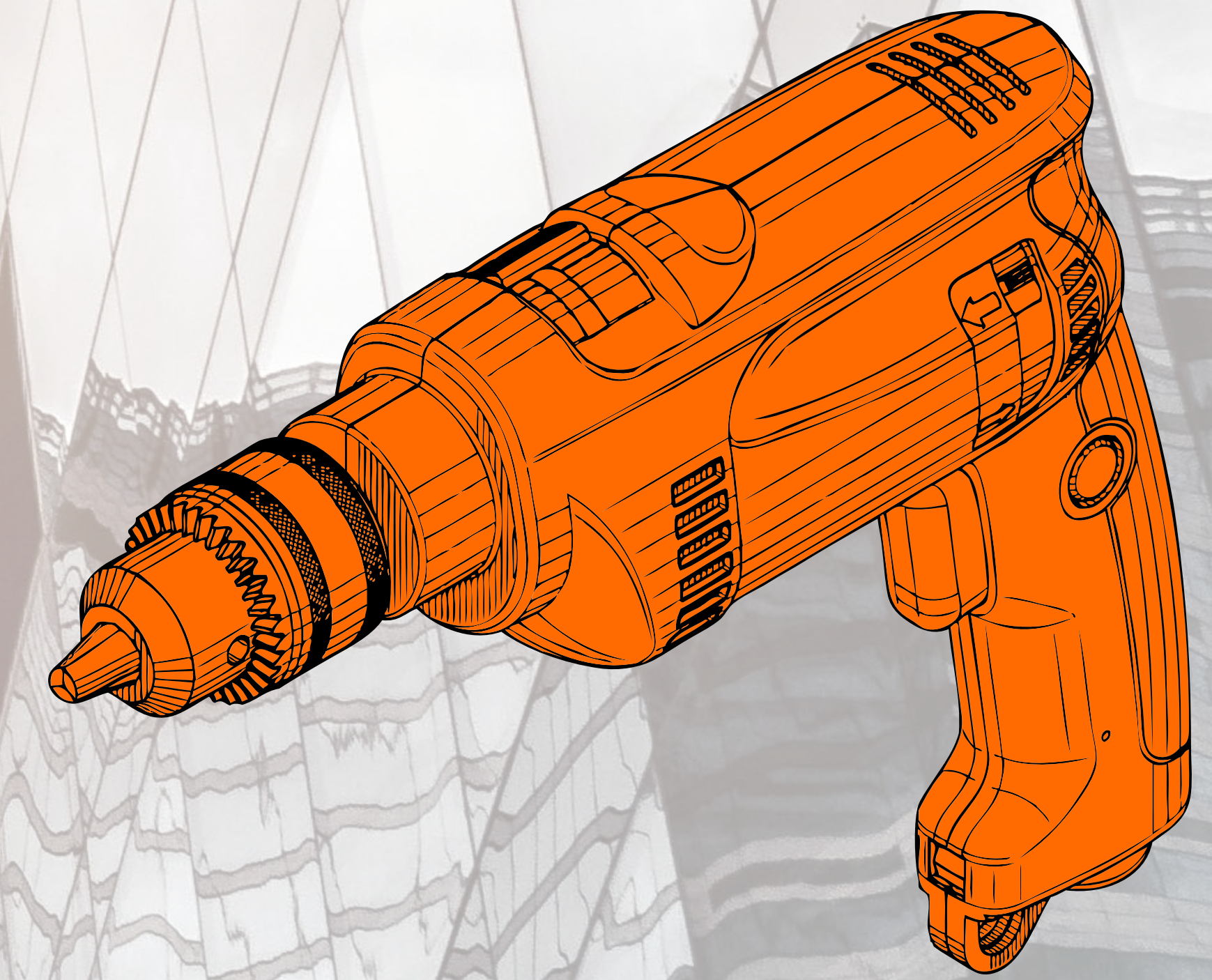

PROJECTS



Project Name	Academic Block(sir syed) No.4 Gc university Faisalabad
Location	Faisalabad
Client	Gc university Faisalabad
Consultant	NESPAK
Civil Contractor	MIR Alam Khan Brothers
Status	COMPLETED
Work Scope	Plumbing Work Complete + Fire Fighting System



Project Name	Girls Hostel (Amina Hall) Gc university Faisalabad
Location	Faisalabad
Client	Gc university Faisalabad
Consultant	NESPAK
Civil Contractor	MIR Alam Khan Brothers
Status	COMPLETED
Work Scope	Plumbing Work Complete + Fire Fighting + Electrical

PROJECTS



Project Name	Admin Block New Campus Gc university Faisalabad
Location	Faisalabad
Client	Gc university Faisalabad
Consultant	NESPAK
Civil Contractor	MIR Alam Khan Brothers
Status	COMPLETED
Work Scope	Plumbing Work Complete + Fire Fighting + Electrical



Project Name	Officer Accommodation Residential 19-22 Gc university
Location	Faisalabad
Client	Gc university Faisalabad
Consultant	NESPAK
Civil Contractor	MIR Alam Khan Brothers
Status	COMPLETED
Work Scope	Plumbing Work Complete + Fire Fighting + Electrical

PROJECTS



Project Name	Nadra Provisional Headquarter Lahore
Location	Lahore
Client	Nadra
Consultant	Progressive consultant
Civil Contractor	HRL Pvt Ltd
Status	COMPLETED
Work Scope	Plumbing Work Complete + Fire Fighting + Electrical



Project Name	New City Arcade Taxila
Location	Taxila
Client	New City Housing
Consultant	Jamshaid Khan Associates
Civil Contractor	Samco Associates
Status	COMPLETED
Work Scope	Gi Piping For Gas

PROJECTS



Project Name	Kalsoom Hostel Bhohtyan Chowk University Of Lahore
Location	Lahore
Client	University Of Lahore
Consultant	Matrix consultant
Civil Contractor	ATCon Conctruction
Status	COMPLETED
Work Scope	Plumbing Work Complete + Core Cutting



Project Name	The National School Multan Road Parkview Lahore
Location	Lahore
Client	Parkview Housing
Consultant	Mansoor Mazhar
Civil Contractor	Vison Developers
Status	COMPLETED
Work Scope	Plumbing Work Complete + Core Cutting + Wall Sawing

PROJECTS



Project Name	E2 Building University Of Lahore
Location	Lahore
Client	University Of Lahore
Consultant	University Of Lahore
Civil Contractor	ATCon Conctruction
Status	COMPLETED
Work Scope	Plumbing Work Complete + Core Cutting



Project Name	Fatimah Hall University Of Lahore
Location	Lahore
Client	University Of Lahore
Consultant	University Of Lahore
Civil Contractor	Premeir Engineering
Status	COMPLETED
Work Scope	Plumbing Work Complete + Core Cutting

PROJECTS



Project Name	Box Park Palaza Bahria Town Rawalpindi
Location	Rawalpindi
Client	BoxPark
Consultant	
Civil Contractor	Client Own
Status	COMPLETED
Work Scope	Plumbing Work Complete + Core Cutting



Project Name	One Express Way Plaza Gulbarg Green Islamabad
Location	Islamabad
Client	Express Way
Consultant	Sohail Ahmid
Civil Contractor	Thaheem Construction
Status	COMPLETED
Work Scope	Plumbing Work Complete + Core Cutting

PROJECTS



Project Name	Universal Cinema Emporium Mall Johar Town
Location	Lahore
Client	Nishat Group
Consultant	Marcus Wilkins & Ali Naqvi AHR Global (UK)
Civil Contractor	Fajar Construction
Status	COMPLETED
Work Scope	Plumbing Work Complete + Core Cutting + Wallsawing



Project Name	Liberty Gate plaza Gulberg Lahore
Location	Lahore
Client	Liberty Gate Plaza
Consultant	
Civil Contractor	
Status	COMPLETED
Work Scope	Plumbing Work + Maintenance Complete

PROJECTS



Project Name	New Islamabad Air Port
Location	Islamabad
Client	F.W.O
Consultant	ADPI
Civil Contractor	H.R.L Pvt Ltd
Status	COMPLETED
Work Scope	Electrical + Plumbing Work Phas2 + Core Cutting + Wallsawing



Project Name	New Islamabad Airport Houstles
Location	Islamabad
Client	F.W.O
Consultant	ADPI
Civil Contractor	Chuhdary Construction
Status	COMPLETED
Work Scope	Plumbing Work + Maintenance Complete

PROJECTS



Project Name	University of Lahore Software Engineering Department
Location	Lahore
Client	University of Lahore
Consultant	University of Lahore
Civil Contractor	University of Lahore
Status	COMPLETED
Work Scope	Plumbing Work Complete + Maintenance + Core Cutting



Project Name	University of Lahore Dental Surgeon Department
Location	Lahore
Client	University of Lahore
Consultant	University of Lahore
Civil Contractor	University of Lahore
Status	COMPLETED
Work Scope	Plumbing Work + Maintenance Complete + Core Cutting

PROJECTS



Project Name	University of Lahore Allied Helath Science
Location	Lahore
Client	University of Lahore
Consultant	University of Lahore
Civil Contractor	West Contruction
Status	COMPLETED
Work Scope	Plumbing Work Complete + Maintenance + Core Cutting



Project Name	University of Lahore Car Parking
Location	Lahore
Client	University of Lahore
Consultant	University of Lahore
Civil Contractor	West Contruction
Status	COMPLETED
Work Scope	Plumbing Work + Maintenance Complete + Core Cutting

PROJECTS



Project Name	University of Lahore Soka Building
Location	Lahore
Client	University of Lahore
Consultant	University of Lahore
Civil Contractor	WestCon Contruction
Status	Running Project
Work Scope	Plumbing Work Complete + Maintenance + Core Cutting



Project Name	University of Lahore Teaching Hospital Bhohtyan Chowk
Location	Lahore
Client	University of Lahore
Consultant	University of Lahore
Civil Contractor	University of Lahore
Status	COMPLETED
Work Scope	Plumbing Work + Maintenance Complete + Core Cutting

PROJECTS



Project Name	Silver Star Mall Fortress Stadium
Location	Lahore
Client	Owner
Consultant	
Civil Contractor	Owner
Status	COMPLETED
Work Scope	Plumbing Work Complete + Maintenance + Core Cutting



Project Name	Stepping Stone School AL Jalil Garden Lahore
Location	Lahore
Client	Al Jalil Garden
Consultant	
Civil Contractor	Bestow Interior
Status	COMPLETED
Work Scope	Plumbing Work + Maintenance Complete + Core Cutting

PROJECTS



Project Name	University of Lahore Shahida Girls Hostel
Location	Lahore
Client	University of Lahore
Consultant	University of Lahore
Civil Contractor	WestCon Contruction
Status	Running Project
Work Scope	Plumbing Work Complete + Maintenance + Core Cutting



Project Name	University of Lahore LBS Department Building
Location	Lahore
Client	University of Lahore
Consultant	University of Lahore
Civil Contractor	WestCon Contruction
Status	Running Project
Work Scope	Plumbing Work + Maintenance Complete + Core Cutting

PROJECTS



Project Name	Islamabad High Court Building Islamabad
Location	Diplomatic Enclave Islamabad
Client	Islamabad High Court (Nlc)
Consultant	
Civil Contractor	Habib Rafique Pvt Ltd
Status	Completed
Work Scope	Electrical + Plumbing + Core Cutting



Project Name	Tricon Coprate Center Lahore
Location	Lahore
Client	Tricon Developers
Consultant	
Civil Contractor	Habib Rafique Pvt Ltd
Status	Completed
Work Scope	Electrical + Core Cutting

PROJECTS

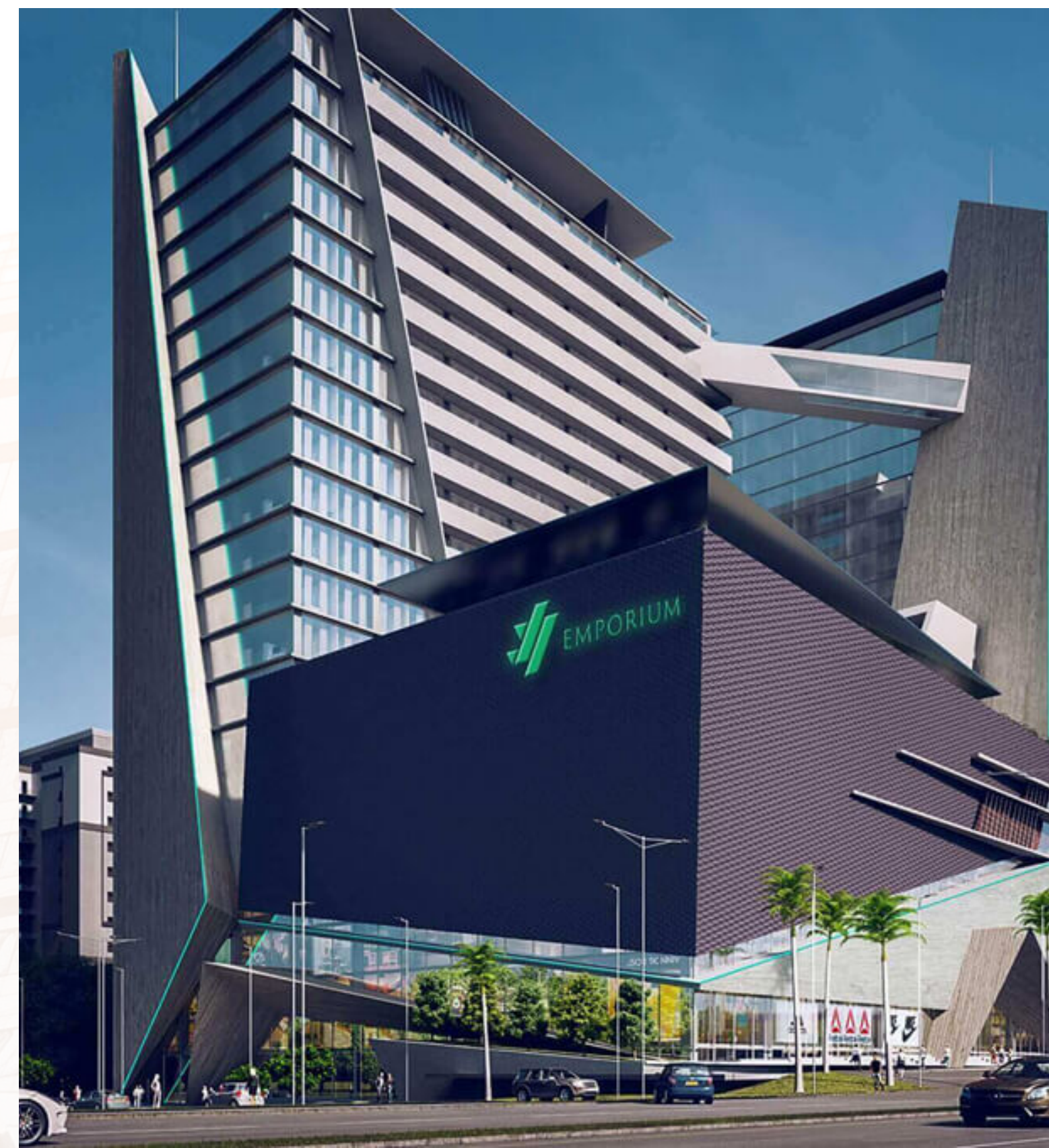

Project Name	J7 Emporium Mall Plot 01 Multi Garden B17
Location	Islamabad
Client	J7 Group
Consultant	Hydrogen (Pty) Ltd
Civil Contractor	J7 Gorup
Status	Running Project
Work Scope	Plumbing Work Complete + Maintenance + Core Cutting



Project Name	J7 Emporium Mall Plot 02 Multi Garden B17
Location	Islamabad
Client	J7 Group
Consultant	Hydrogen (Pty) Ltd
Civil Contractor	J7 Gorup
Status	Running Project
Work Scope	Plumbing Work + Maintenance Complete + Core Cutting

PROJECTS



Project Name	J7 Icon Apartments Mumtaz City
Location	Islamabad
Client	J7 Group
Consultant	
Civil Contractor	J7 Gorup
Status	Running Project
Work Scope	Plumbing Work Complete + Electric Earthing + Core Cutting



Project Name	J7 Solitaire Apartments Mumtaz city
Location	Islamabad
Client	J7 Group
Consultant	Hydrogen (Pty) Ltd
Civil Contractor	J7 Gorup
Status	Running Project
Work Scope	Plumbing Work Complete + Electric Earthing + Core Cutting

PROJECTS



Project Name	Suparco House Dha Rawalpindi
Location	Rawalpindi
Client	Suparco Pakistan
Consultant	
Civil Contractor	CM Developers
Status	Running Project
Work Scope	Plumbing Work Complete + Maintenance + Core Cutting



Project Name	PCHF Hospital Uol Bhohtyan Chowk Lahore
Location	Lahore
Client	University of Lahore
Consultant	University of Lahore
Civil Contractor	Westcon Construction
Status	Running Project
Work Scope	Plumbing Work Complete + Maintenance+ Core Cutting

REGISTRATION

INCORPORATION

SECURITIES AND EXCHANGE COMMISSION OF PAKISTAN

Company Registration Office

CERTIFICATE OF INCORPORATION

[Under section 16 of the Companies Act, 2017 (XIX of 2017)]

Corporate Unique Identification No. 0207708

I hereby certify that **PLUMBCO ENGINEERING (PRIVATE) LIMITED** is this day incorporated under the Companies Act, 2017 (XIX of 2017) and that the company is limited by shares.

Given at Islamabad this Fourth day of August, Two Thousand and Twenty Two



Moeen Rajput
Moeen Rajput
Deputy Registrar



https://eservices.secp.gov.pk/eServices/ControllerServlet?request_id=VERIFY_ONLINE_INCORP_CERT&id=0207708

TAX PAYER



Government of Pakistan
Federal Board of Revenue
Inland Revenue Services

TAXPAYER REGISTRATION CERTIFICATE

[Under Section 181C of the Income Tax Ordinance 2001]

Registration No.	9963419	 9963419
Date of Registration	04-Aug-2022	
Type of Person	Company	
Inc. No.	0207708	
Inc. Date	04-Aug-2022	
Name	PLUMBCO ENGINEERING (PRIVATE) LIMITED	
Address	Office #1064, Street 49 B Block, Multi Garden Islamabad, Pakistan	
Tax Office	CTO ISLAMABAD	
Activity Type	Business	

This is a computer generated certificate and, hence, no signatures are required.

Displaying of Taxpayer Registration Certificate is mandatory as provided under section 181C of Income Tax Ordinance 2001.

This is not a valid evidence of being a "filer" for the purposes of clauses (23A) and (35C) of sections 2 and 181A of the Income Tax Ordinance 2001.

REGISTRATION

NTN REGISTRATION

GST REGISTRATION

8/4/22, 8:22 PM

Taxpayer Profile Inquiry

Printed On: 8/4/2022 8:22:29 PM

Registration No 9963419
Reference No 9963419-5
Registered for Sales Tax No
Name PLUMBCO ENGINEERING (PRIVATE) LIMITED
Category Company formed and registered under the Companies Ordinance, 1984 or any other law repealed thereunder
PP/REG/INC No. 0207708
Email sai****tar***@gmail.com
Cell 00923**890**05
Address Office #1064, Street 49 B Block, Multi Garden Islamabad, Pakistan
Registered On 04-AUG-2022
Tax Office CTO ISLAMABAD
Registration Status Income Tax: Active

Sr.	Business/ Branch Name	Business/ Branch Address	Principal Activity
1	PLUMBCO ENGINEERING (PRIVATE) LIMITED	Office #1064, Street 49 B Block, Multi Garden Islamabad, Pakistan	432900-Construction/Electrical, plumbing and other construction installation activities/Other construction installation

8/7/22, 5:12 PM

Taxpayer Profile Inquiry

Printed On: 8/7/2022 5:12:49 PM

Registration No 9963419
Reference No 9963419-5
Registered for Sales Tax Yes. w.e.f. 07-AUG-22
Name PLUMBCO ENGINEERING (PRIVATE) LIMITED
Category Company formed and registered under the Companies Ordinance, 1984 or any other law repealed thereunder
PP/REG/INC No. 0207708
Email sai****tar***@gmail.com
Cell 00923**890**05
Address Office No. 1064, Street No. 49 B Block, Multi Garden Islamabad, Islamabad
Registered On 04-AUG-2022
Tax Office CTO ISLAMABAD
Registration Status Income Tax: Active , Sales Tax: OPERATIVE

Sr.	Business/ Branch Name	Business/ Branch Address	Principal Activity
1	PLUMBCO ENGINEERING (PRIVATE) LIMITED	Office # 1064 Street 49 B Block, Multi Garden, Islamabad, Islamabad	432200-Construction/Electrical, plumbing and other construction installation activities/Plumbing, heat and air-conditioning installation

CONTACT US

 **0304.8902805**

 **0512763508**

 **QUERY@PLUMBCOENGINEERING.COM**

 **WWW.PLUMBCOENGINEERING.COM**

 **ISLAMABAD: G7 GROUND FLOOR EMAN ARCADE B-BLOCK COMMERCIAL AREA MULTI GARDEN B-17 ISLAMABAD**

 **LAHORE: #1,2 2ND FLOOR HAJI ELECTRONICS PLAZA RAIWIND ROAD ALI RAZA ABAD LAHORE**

 **KARACHI: A59 KARACHI UNIVERSITY SOCIETY SCHEME 33 GULZAR E HIJERY KARACHI**